

Data Sheet



Article number: 586350416

Description: Ball Valve 350.416, G 2 1/2" - G 2 1/2"
Thread/Thread

Measures

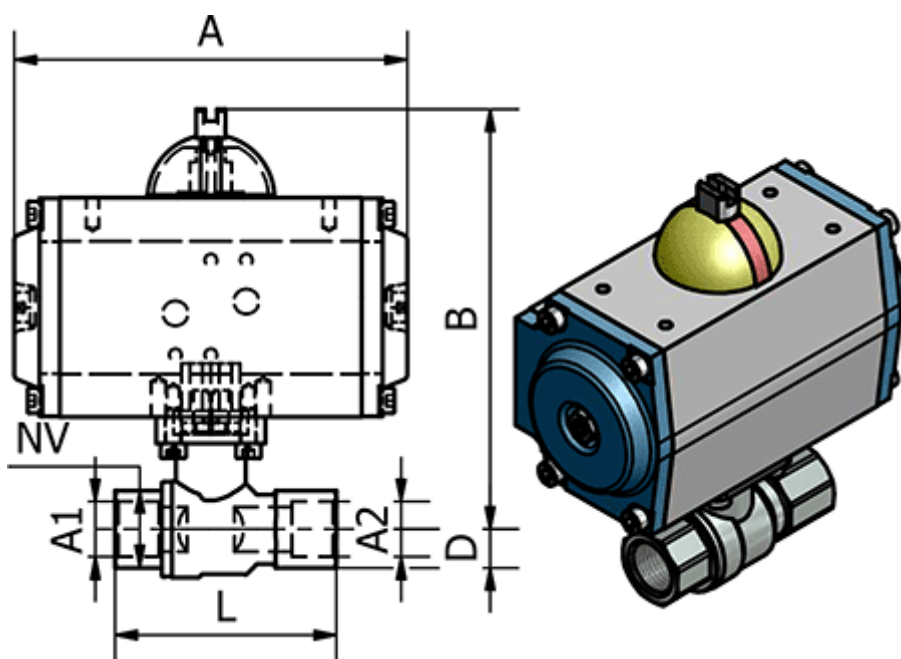

A	= 209
B	= 230
Connecting A1	= G 2 1/2"
Connecting A2	= G 2 1/2"
D	= 57
L	= 155
Max. Operating Pressure	= 16 bar
NV	= 83